

SALUS[®]

C O N T R O L S

iT500 Internet Thermostat



INSTALLER MANUAL

1. Product compliance & safety information

These instructions are applicable to the SALUS Controls model stated on the front cover of this manual only, and must not be used with any other make or model.

This accessory must be fitted by a competent person, and installation must comply with the guidance provided in the current IEE Wiring Regulations and current Building Regulations. Failure to comply with the requirements of these publications could lead to prosecution.



Always isolate the AC Mains supply before installing or working on any components that require 230 VAC 50Hz supply.

**When fitting batteries, do not mix old and new batteries together.
Do not use rechargeable batteries.**

Please leave these instructions with the end user where they should be kept in a safe place for future reference.

2. Installation of the iT500RX Receiver



Loosen the screws at the bottom of the receiver unit.



Unclip the front of the unit.

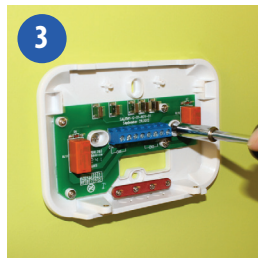

Fit the back of the receiver unit to the wall using the fittings supplied.

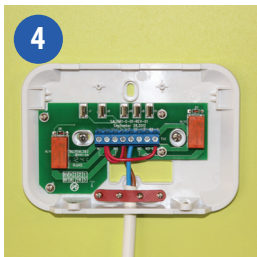

Wire up the receiver using one of the schematics on pages 4 and 5



Clip the front of the unit back on by aligning the fittings and pushing into place.



Securely screw the front of the receiver in place.

3. WIRING SCHEMATICS FOR SYSTEM CONFIGURATIONS

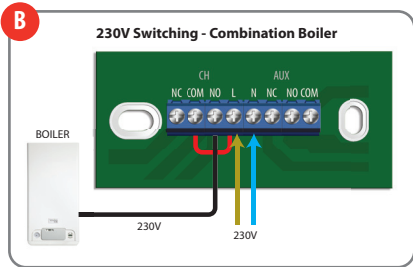
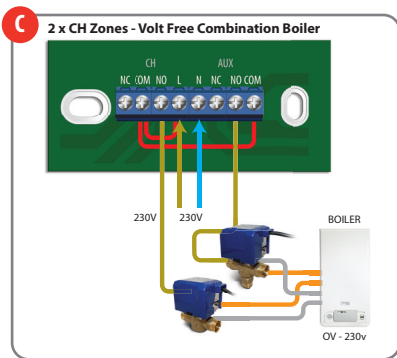
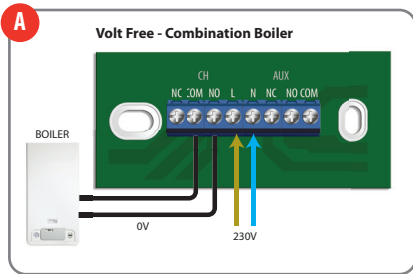

A One central heating zone only.

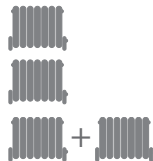

B One central heating zone only.

C Two central heating zones.
iT300 Sensor required for this configuration.

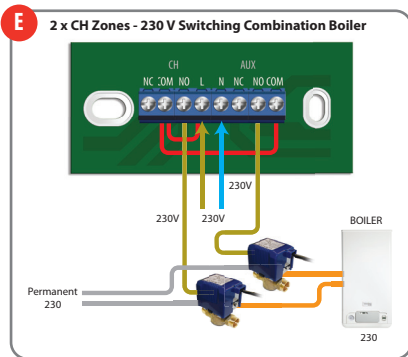
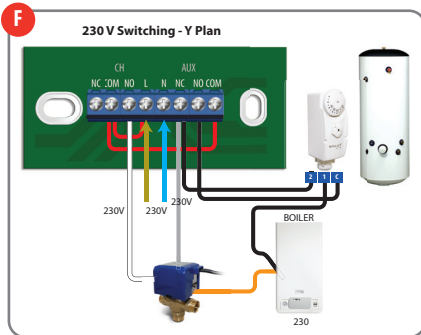
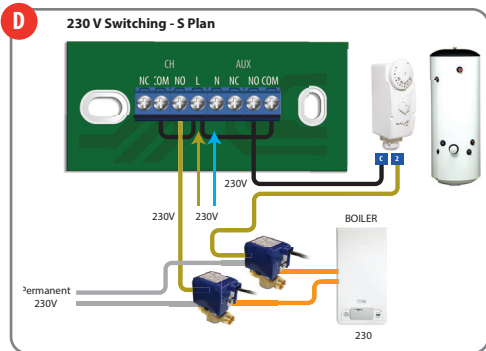

3. WIRING SCHEMATICS FOR SYSTEM CONFIGURATIONS



- D** One central heating zone plus hot water. 
- E** Two central heating zones.  iT300 Sensor required for this configuration.
- F** One central heating zone plus hot water. 

4. Installation of wall bracket docking (optional)



1
Attach the wall mounting bracket to a suitable wall using the fittings supplied and the built-in level.



2
After first ensuring that the bracket is secure, clip the iT500 into place by aligning the recess on the back of the unit to the bracket and clipping into place.



3
Once clipped into place, ensure the unit is securely seated on the bracket.

i For best results mount the iT500 1.5m from ground level.

5. Desk mount option iT500



For the desk mounted option, simply clip the clear stand supplied separately into the back of the unit.

6. Connecting the Gateway to your existing router

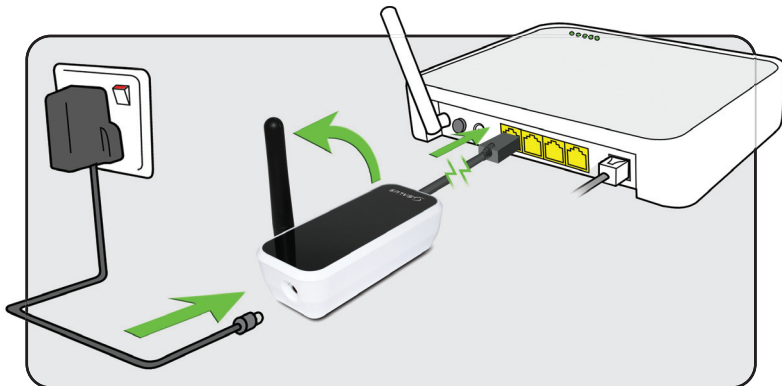

Flashing red light
on setup.



You require port 80 and 2165 UDP open on the router



Constant green light when the iT500 is connected to the SALUS Controls Server.

7. Inserting the batteries in the iT500 Thermostat

1



Remove the battery cover from the base of the iT500 Thermostat.

2



Make a note of the serial number printed in the base of the iT500 Thermostat.

3



With the unit face down, insert the first battery supplied into the right hand side of the base of the iT500 Thermostat.

4



Insert the second battery supplied into the left hand side of the base of the iT500 Thermostat.

5



Ensure the batteries are fitted securely in the base of the iT500 Thermostat.

6



Replace the battery cover to the base of the iT500 Thermostat.



Why not make a note of your STA number here for future reference.

S	T	A																	
---	---	---	--	--	--	--	--	--	--	--	--	--	--	--	--	--	--	--	--

8. Setting up the iT500 Thermostat

After powering up iT500 for the first time the display will go through the following sequence.



OTA* Revision number



iT500 Software revision













The globe icon  will appear when the unit automatically connects to the internet via the SALUS iTG500 Gateway. This should take approximately 20 seconds.



* Over The Air operated software

9. LCD Overview

LCD ICONS	DESCRIPTION	FUNCTION
1 2 3 4 5 6 7	Day of the week	Displays the number of the day of the week. 1 being Monday
88 ^{°E} _B	Temperature indicator	Displays set or measured temperature
88:88	Clock display	Displays time
1 2 3 4 5 6	Program number indicator	Displays the number of the active (selected) program
	Heat mode indicator	Indicates heating output is turned on*
	Heat zone indicator	Indicates heating zone*
	Hot water indicator	Indicates hot water control*
	Hot water mode indicator	Indicates hot water output is turned on*
	RF signal indicator	Indicates the unit is transmitting a wireless signal to the iT500RX or is receiving the signal from the iT300*
	Touch lock indicator	Indicates touch lock is activated
	Battery status	Indicates battery is low
	Holiday indicator	Indicates holiday operation mode is selected
	Internet indicator	Indicates connection to iTG500 and SALUS server
	Cooling indicator	Indicates cooling output is on*
ON	ON indicator	Hot water continuously on*
1	Once indicator	Hot water is on once*
AUTO	AUTO indicator	Automatic program mode
OFF	OFF indicator	Off mode
	Setting indicator	Manual override or settings mode

*System configuration specific.

Selecting your system configuration

Based on your system wiring on page 4.



If the iT500 is to be used in the UK for single zone heating then there is no need to enter system configuration setup, please proceed to page 15.



Note! This menu should only be entered by the installer as changes can have a detrimental effect on your heating system.



At any time press and hold  for 5 seconds to return to the home screen.

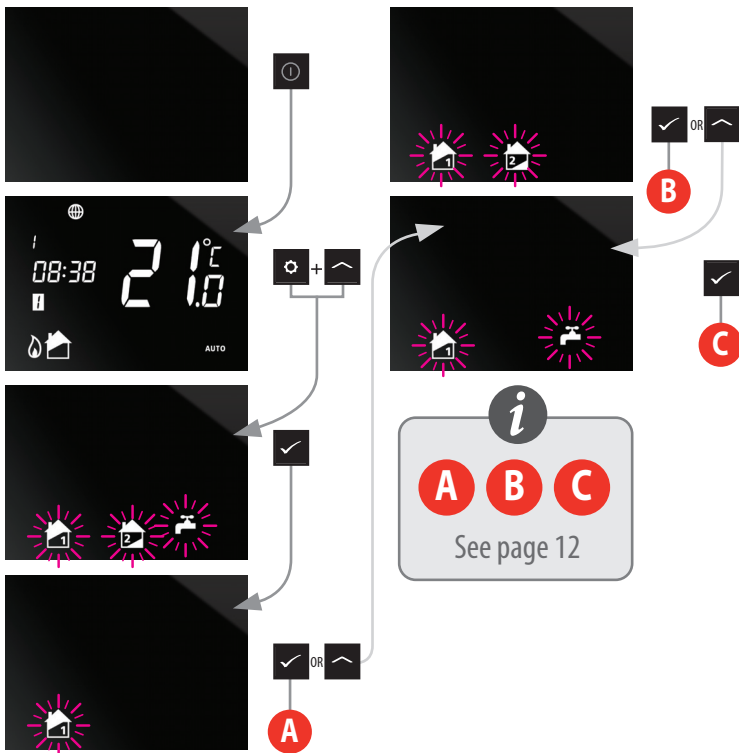

Now that you have selected your system configuration you can continue with the rest of the installation setup.

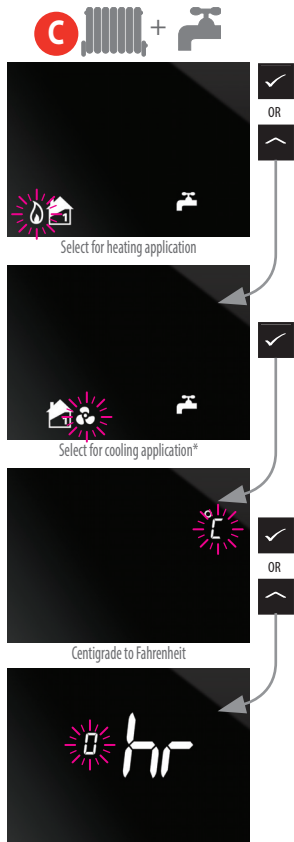
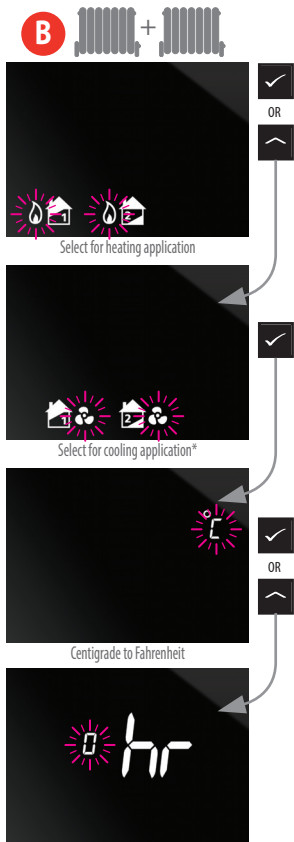
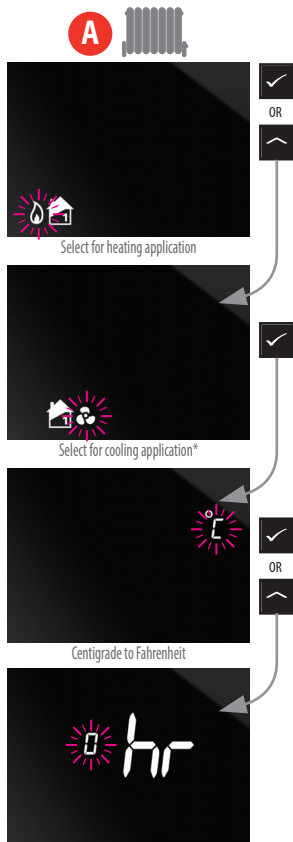

* Cooling can only be selected if your system supports this.
 ** Please refer to the following page for your region.

10. European Time Zones

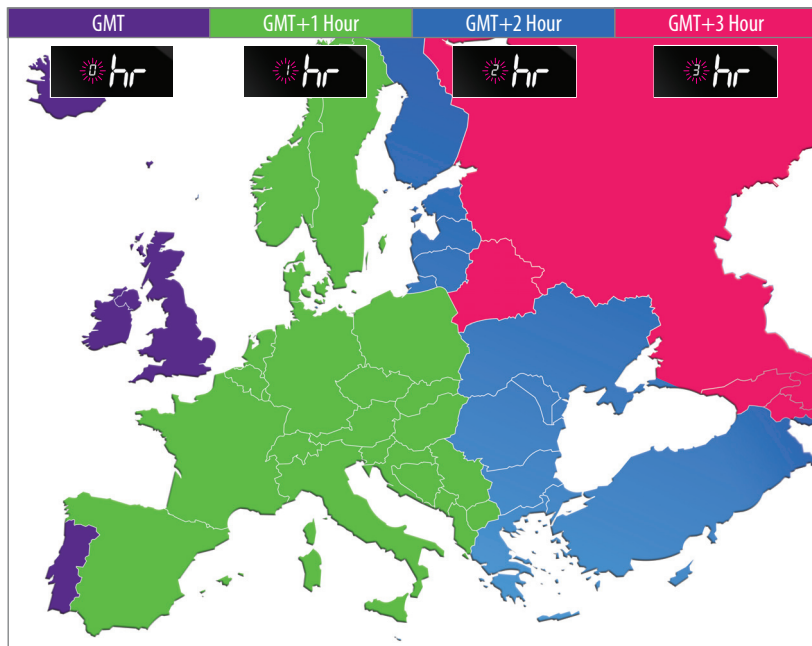

UK
IRELAND
PORTUGAL
ICELAND*

AUSTRIA
POLAND
GERMANY
CZECH
SPAIN
FRANCE
ITALY
SWITZERLAND
LUXEMBOURG
HOLLAND

BELGIUM
DENMARK
SWEDEN
NORWAY
MALTA
CROATIA
SERBIA
BOSNIA
SLOVENIA

ESTONIA
TURKEY
CYPRUS
GREECE
ROMANIA
RUSSIA
UKRAINE

BULGARIA
LITHUANIA
BELARUS*
FINLAND
MOLDOVA
LATVIA

RUSSIA*



The countries marked with * do not observe Daylight Saving Time

Now that you have selected your system configuration you can continue with the rest of the installation setup. DST (daylight saving time) ON will automatically change your time from summer to winter.

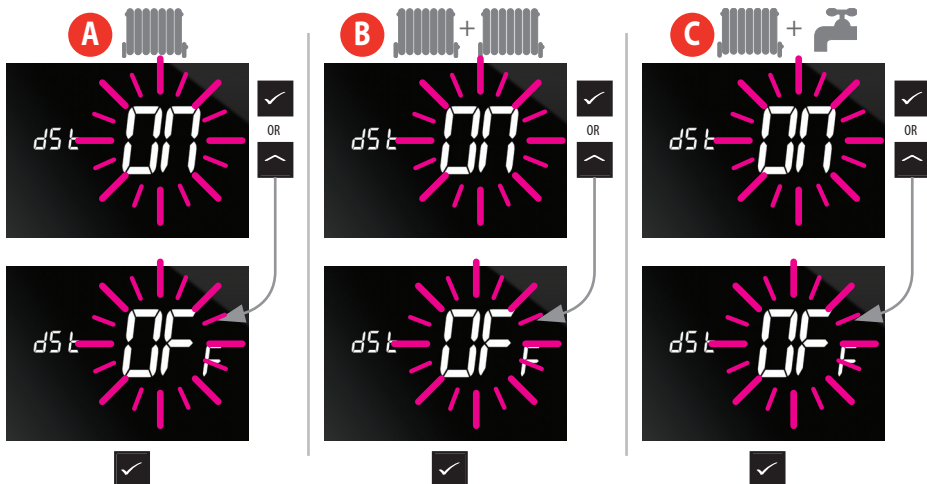

11. Pairing the iT500 with the iT500RX Receiver





Using a paper clip, insert into the hole marked SYNC at the bottom of the iT500RX Receiver. Then work through the screen sequence shown on the next page.



The bottom switch will show a constant red light when the iT500RX Receiver is ready to pair. Now go to the iT500 Thermostat.

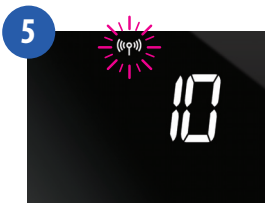

FAILSAFE MODE: In the event of RF signal loss, your system will be switched on for 4 minutes, then off for 11 minutes. If you want to disable FAILSAFE MODE when RF link has been lost then move the slide switch on the iT500RX to either the manual or off position.



When the iT500RX Receiver and the iT500 Thermostat are paired then the light will be green.

Press



to return to home screen.

Receiver LED colours



The bottom switch will show a constant red light when the iT500RX Receiver is ready to pair.



When the iT500RX Receiver and the iT500 Thermostat are powered and paired then the light will be green.



Flashing blue light indicates a heat call/Hot water call



FAILSAFE MODE: In the event of RF signal loss, your system will be switched on for 4 minutes, then off for 11 minutes. If you want to disable FAILSAFE MODE when RF link has been lost then move the slide switch on the iT500RX to either the manual or off position.

12. Fitting the wall bracket and mounting the iT300

i

Used for 2
central heating
zones only

Note: iT300 purchased separately. Can only be used if your system supports two central heating zones. See pages 4 and 5.

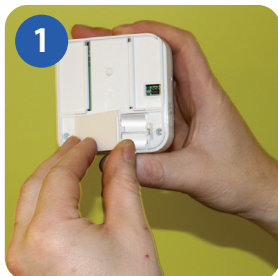

Remove the battery cover on the back of the iT300 unit.

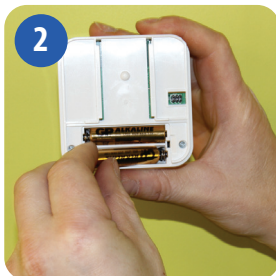

Insert the 2x AAA batteries supplied into the iT300 unit.

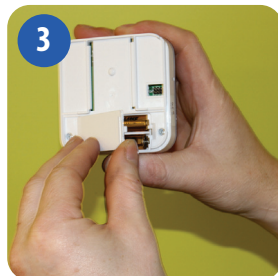

Replace the battery cover.



Attach the wall mounting bracket to a suitable wall using the fittings supplied.



Align the grooves on the back of the iT300 unit and slide onto the bracket.



Once in place, ensure the unit is securely seated on the bracket.

13. Pairing the iT300 to the receiver



To pair the iT300 to the receiver, insert a paperclip or similar object into the hole on the left hand side of the iT300 for 2 seconds.



A red light will flash in the top right hand corner of the iT300.

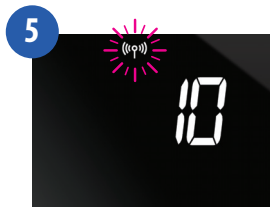
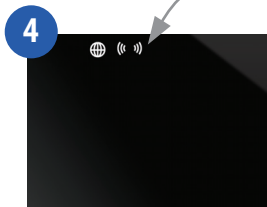

i The iT300 should be installed in the area of the house that the second zone will be controlled from, ie. Upstairs.

The iT500 has successfully paired with the iT300 when the antenna stops flashing.

Press OR

to return to home screen.

Please note the red LED on the iT300 will continue to flash and eventually timeout.

14. Registering and operating your iT500 online

1



Go to the SALUS controls website. www.salus-controls.com and select your relevant country

2



Click on the register iT500 icon on the left hand side of your country's website

14. Registering and operating your iT500 online

3



Click on REGISTER

4



Fill in the online form and click REGISTER

5



The above screen will show and a confirmation email will be sent to you

14. Registering and operating your iT500 online

6

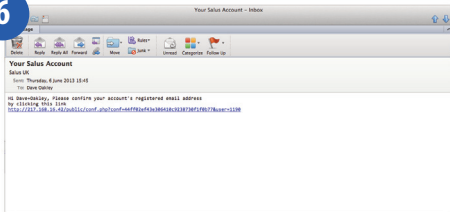

You will receive a confirmation email. Click on the link to complete your registration.

7



Now use your username and password to log in.

8

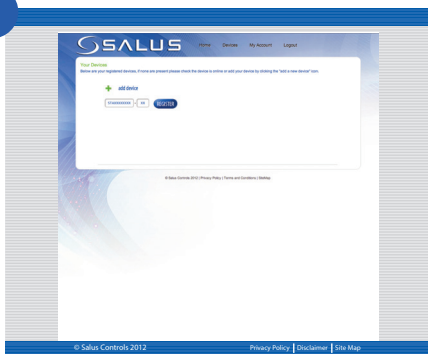

Enter the iT500 STA number (Please refer to page 8). Then press REGISTER.

9



Your iT500 will appear as above and is now ready to be controlled or viewed via your PC or Smartphone. Just click on the iT500 icon on your PC.

15. Download Smartphone App

Once you have registered your iT500 online you can also download the smartphone App from the iPhone App Store or the Android App Store depending on which kind of Smartphone you are using. Find the iT500 App on the App Store and click download. The App will automatically download to your Smartphone and once downloaded you can begin controlling your iT500 Thermostat.

www.salus-controls.com ————— Go to the salus-controls.com website.



————— Click on the relevant App Store icon.



————— Find the SALUS iT500 App and click download.

16. Adding or renaming the iT500 in your device list



Enter your user ID and password.
Press **LOG IN**



When you first open the iT500 App your iT500 will appear in the device list and you can begin controlling it with your Smartphone.



If you add more than 1 iT500 to your device list, you may wish to rename the iT500 to "DOWNSTAIRS" for example. Click on **RENAME** and enter a new name.



If you forget your password, follow the on screen instructions.



For full information on PC and Smartphone operation please refer to the user manual.

Trouble shooting

Q. Can I operate the heating using the iT500 unit if I have no internet connection?

A. Yes, most functions can be operated from the iT500 unit.

Q. Why do my iT500 buttons not work?

A. Check that the screen lock is not active. If active, there will be a padlock visible in the top of the LCD. Disable by pressing and holding top two left keys on the iT500.

Q. Why does my heating never come on?

A. Check that the iT500 is in AUTO mode, 'AUTO' should be visible at the bottom right on display. If showing 'OFF' press the TICK and SETTINGS buttons, then use the UP/DOWN arrow keys to change OFF to AUTO then TICK to confirm.

Q. I've tried doing the software upgrade (Green Button appeared on the iT500 web page) but it failed...

A. Check the gateway is plugged into the router and it has a green light.

A. Position the iT500 within 1 meter of the SALUS Gateway unit.

A. If you receive the message 'Failed' please try running the OTA again.
(Due to internet speed this may take several attempts)

Q. Where do I download my Smartphone app to control the iT500?

A. If you have an iPhone, please search for iT500 on the app store, if you have an Android; search for iT500 on Google play.

Q. What does the Smartphone App do?

A. It lets you control the iT500 remotely over the internet. You have full remote access to your heating control giving both temporary and program changes.

Trouble shooting

Q. I can't access my iT500 on my PC or Smartphone after registering it?

- A. Check you received your confirmation email from SALUS and clicked on it.
- A. Check you entered the correct email and password as used on registration.
- A. Ensure you added your device STA number which is located in the battery compartment of the iT500. You should see an image of your device after log-in, click on it to access.

Q. I have installed the device and registered online but my heating is not coming on.

- A. Check that the top slide switch on the receiver unit is in the AUTO position.
- A. Perform a quick installation check by putting the top slide switch to Manual position, and the bottom slide switch to CH. The boiler should fire, if not the iT500 receiver may be wired incorrectly. Please contact your installer.

Q. My receiver has a flashing blue light... what is that?

- A. A flashing Blue light is normal indication that the iT500 thermostat is asking for heat and the boiler should be on.

Q. My receiver has a flashing Yellow light... what is that?

- A. A flashing Yellow light is fault indication. The iT500 receiver unit has lost communication with the thermostat. Check the thermostat distance from its receiver, and check for major metalwork in its communication path (such as fridge/freezers). Reposition the thermostat to improve communication. Once it establishes communication again the fault will clear automatically.

Trouble shooting

- Q. The App says my iT500 is OFFLINE and my iT500 does not have the internet globe indicator on the screen, why is this?**
- A. Check that you have the power supply turned ON to the gateway and it has a steady green light showing. The green light indicates you are connected to the SALUS server.
- A. If you have all the above, remove a battery from the iT500 and replace after 10 seconds. This will reboot the iT500 and bring you back online.
- Q. I've just plugged the SALUS gateway into my Belkin and the gateway has a solid RED light, what is this?**
- A. The gateway must be connected to a network that has DHCP enabled, it must be connected to a network that has the firewall ports 80 (UDP/TCP) and 2165 (TCP) open. (You may need to contact your internet provider to assist you changing your router settings.)
- Q. I have a new BT Hub 5 router and the gateway has a solid red light.**
- A. BT Hub 5 uses ports 3 and 4.
- Q. Just had the iT500 installed and my heating isn't coming on?**
- A. Have you paired the thermostat with the receiver, please see page 15 in the installer manual on how to do this.

17. Warranty

SALUS Controls warrants that this product will be free from any defect in materials or workmanship, and shall perform in accordance with its specification, for a period of two years from the date of installation. SALUS Controls sole liability for breach of this warranty will be (at its option) to repair or replace the defective product.

Customer Name:

Customer Address:

..... Post Code:

Tel No: Email:

Engineers Company:

Tel No: Email:

Installation Date:

Engineers Name:

Engineers Signature:

SALUS Controls plc

SALUS House

Dodworth Business Park South,

Whinby Road,

Dodworth, Barnsley S75 3SP

UK.

SALES: T: +44 (0) 1226 323961
E: sales@salus-tech.com

TECHNICAL: T: +44 (0) 1226 323961
E: tech@salus-tech.com

www.salus-controls.com



SALUS Controls is a member of the Computime Group

Maintaining a policy of continuous product development SALUS Controls plc reserve the right to change specification, design and materials of products listed in this brochure without prior notice.

Issue Date: Sept 2013